

PRODUCT SPECIFICATION

Model No.: FYL-5019EGW1B-CC

| Descriptions: |
|---------------------------------------|
| ■ Dice material: GaP/GaP |
| ■ Emitting Color: Orange/Yellow green |
| ■ Device Outline: Φ5mm round type. |
| ■ Lens Type: White Diffused |



| CUSTOMER APPROVED SIGNATURES | APPROVED BY | CHECKED BY | PREPARED BY |
|------------------------------|-------------|------------|-------------|
| | | | |

NINGBO FORYARD OPTOELECTRONICS CO.,LTD.

Add: NO.115 Qixin Road Ningbo Zhejiang China

Zip: 315051

Tel: 0086-574-87933652 87927870 87922206

Fax: 0086-574-87927917

E-mail: Sales@foryard.com (General)

[Http://www.foryard.com](http://www.foryard.com)

■ Features

1. Low power consumption.
2. High efficiency.
3. General purpose leads.
4. RoHs compliant.

■ Package configuration

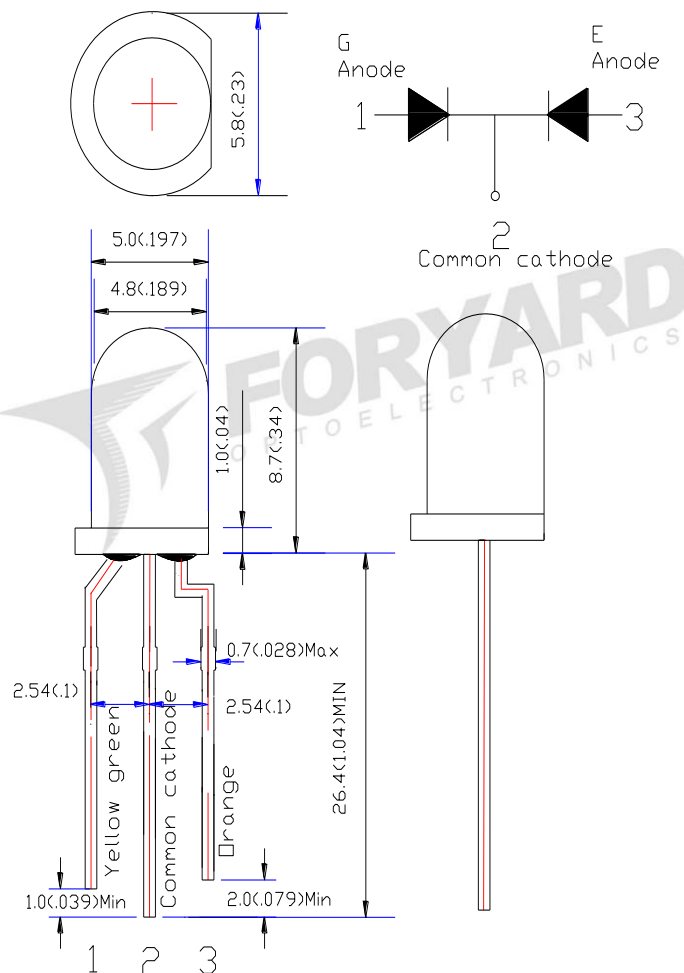

Notes:

1. All dimensions are millimeters (inches)
2. Tolerance is $\pm 0.25\text{mm} (.010\text{'})$ unless otherwise noted.
3. The specifications, characteristics and technical data described in the datasheet are subject to change without prior notice.

■ Absolute maximum ratings(Ta=25 °c)

| Parameter | MAX. | Unit |
|---|---------------------|-------|
| Power Dissipation | E 75 | mW |
| | G 75 | |
| Peak Forward Current (1/10 Duty Cycle, 0.1ms Pulse Width) | 100 | mA |
| Continuous Forward Current | 30 | mA |
| Derating Linear From 50°C | 0.4 | mA/°C |
| Reverse Voltage | 5 | V |
| Operating Temperature Range | -40°C to +85°C | |
| Storage Temperature Range | -40°C to +100°C | |
| Lead Soldering Temperature[4mm(.157") From Body] | 260°C for 5 Seconds | |

■ Electrical and optical characteristics(Ta=25 °c)

| Parameter | Symbol | Min. | Typ. | Max. | Unit | Test Condition |
|--------------------------|-------------------|-------|------|------|------|----------------------|
| Luminous Intensity | I _v | E - | 40 | - | mcd | I _F =20mA |
| | | G | 80 | | | |
| Viewing Angle | 2θ _{1/2} | E - | 50 | - | Deg | |
| | | G | 50 | | | |
| Peak Emission Wavelength | λ _p | E 618 | 625 | 630 | nm | |
| | | G 563 | 568 | 573 | | |
| Dominant Wavelength | λ _d | E 615 | 620 | 625 | nm | |
| | | G 567 | 572 | 577 | | |
| Spectral Line Half-Width | Δλ | E 10 | 15 | 20 | nm | |
| | | G 15 | 20 | 25 | | |
| Forward Voltage | V _F | E 1.8 | 2.0 | 2.4 | V | |
| | | G 1.8 | 2.3 | 2.6 | | |
| Reverse Current | I _R | | | 10 | μA | V _R =5V |

■ Typical Electrical Characteristics Curves

(25 °c Ambient Temperature Unless Otherwise Noted)

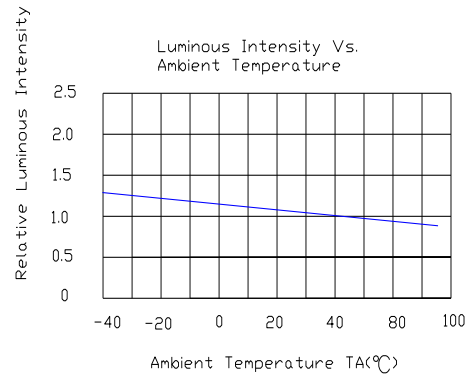
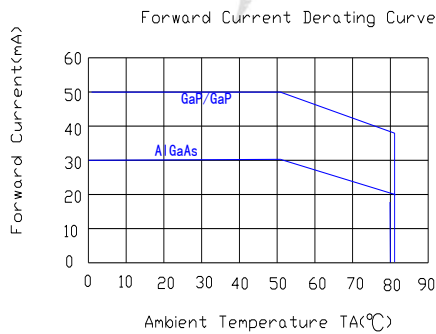
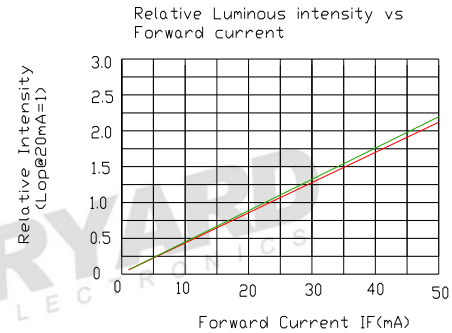
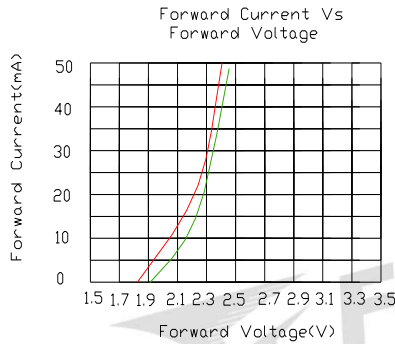
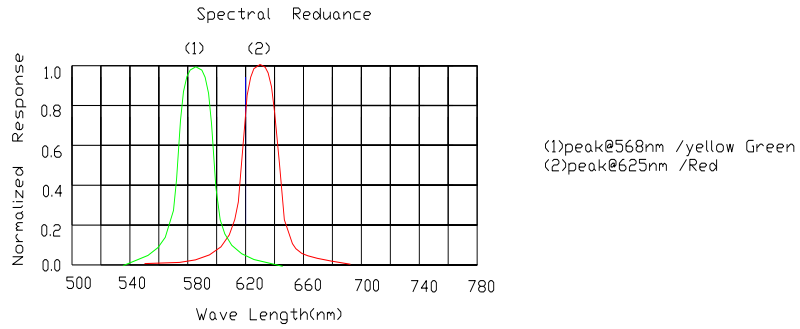

Radiation pattern.

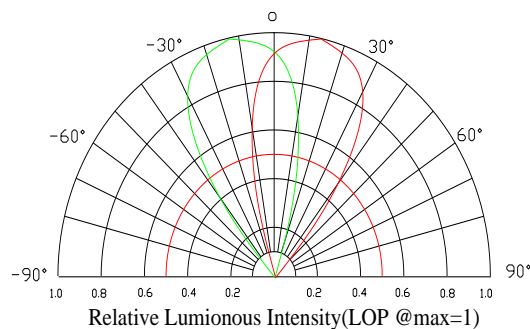

| | |
|------------|------------------|
| Model. No. | FYL-5019EGW1B-CC |
| Rev. | A |

■ LAMP PACKING.

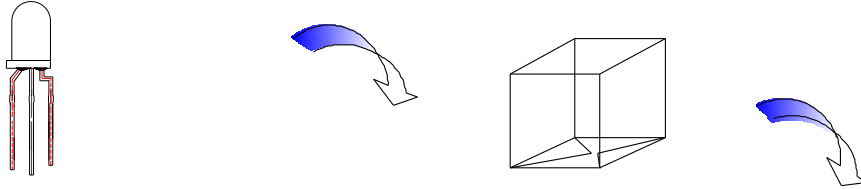

5mm 500PCS/Polybag

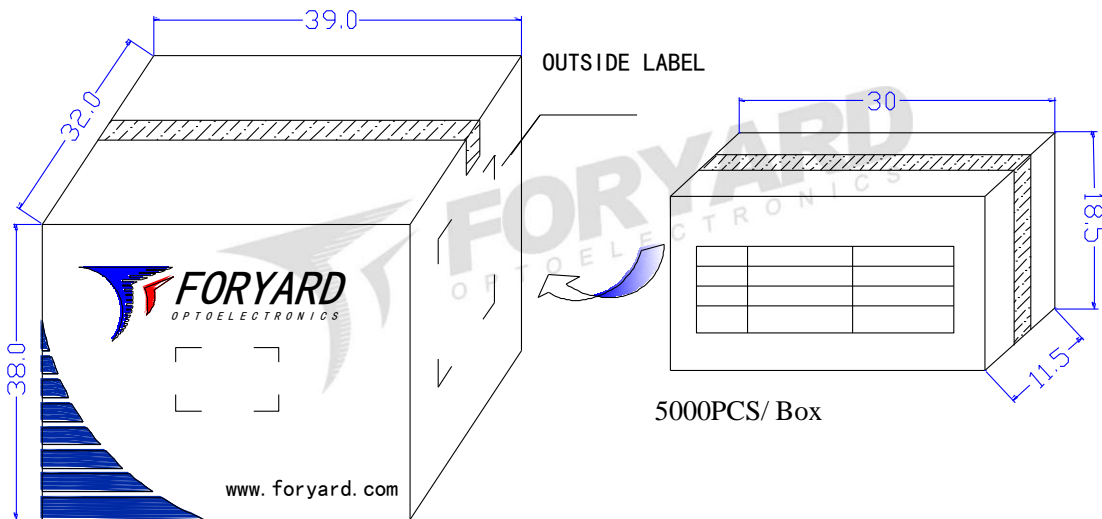
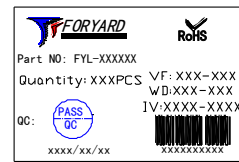

30000PCS/ Carton



OUTSIDE LABEL