



东莞市金倍利电器科技有限公司

DONGGUAN CITY JINBEILI ELECTRICAL TECHNOLOGY CO., LTD.

金葆利（香港）有限公司

JINBAOLI (HONGKONG) LIMITED

## 样品承认书

SAMPLE APPROVAL SHEET

客户名称 CUSTOMER NAME: 深圳鹏烁科技有限公司

物料编码 PRODUCT CODE:

物料型号 PRODUCT MODEL: TC00100AH9.5F160

公司确认 COMPANY APPROVAL:

日期 DATE: 2023.8.22

送样SAMPLE FROM	制作WRITTEN BY	核准APPROVED BY
孔金凤	尹聪	李小勤

客户确认 CUSTOMER APPROVAL:

日期 DATE:

检查 TESTED BY	核对 CHECKED BY	核准APPROVED BY

请确认后，拷贝一份寄给我们参考。谢谢！

Send us a copy of reference. Thank you !

东莞市金倍利电器科技有限公司

DONGGUAN CITY JINBEILI ELECTRICAL TECHNOLOGY CO., LTD.

地址: 广东省东莞市常平镇朗贝村新环路

ADD.: XINHUAN RD., CHANGPING, DONGGUAN, GUANGDONG, CHINA

电话 TEL: 0769-83339095 传真 FAX: 0769-83984949

网址 WEB.: [Http://WWW.JBL-HK.COM](http://WWW.JBL-HK.COM)

REV NO./版次	REVISION NOTE/修订注释	DATE/日期	SIGNATURE/签名

**ELECTRICAL CHARACTERISTICS**

1. RATING: DC 12V 0.05A
2. CONTACT RESISTANCE: 100mΩ MAX
3. INSULATION RESISTANCE: 100MΩ MIN
4. DIELECTRIC STRENGTH: AC 250V (50~60Hz) /60S

**MECHANICAL CHARACTERISTICS**

1. PRACTICAL TEMPERATURE RANG: -40℃~+85℃
2. OPERATING FORCE: 160±50gf
3. MECHANICAL LIFE: 100,000 cycles

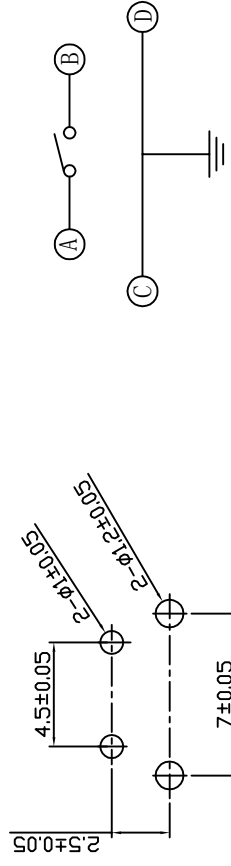
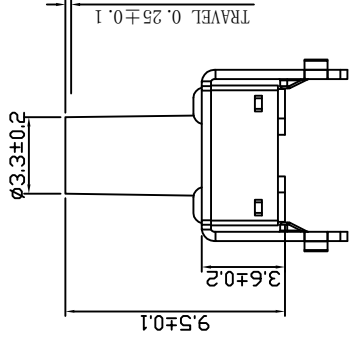
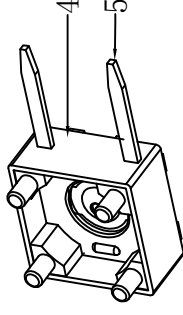
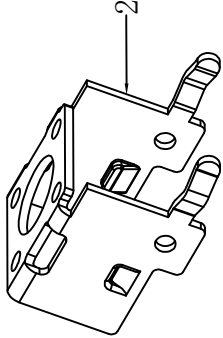
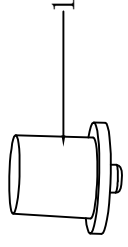
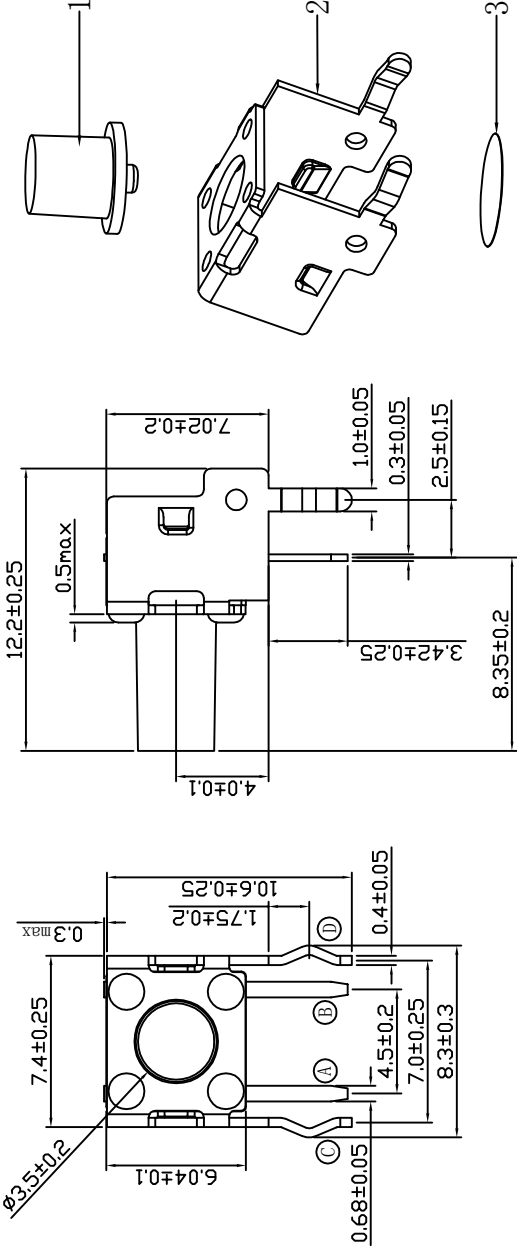

P. C. B. LAYOUT

SCHEMATIC

5	TERMINAL	BRASS STRIP	2	Ag PLATED
4	CASE	PPA	1	BLACK
3	CONTACT	SUS	1	Ag PLATED
2	COVER	SPCC	1	Ni PLATED
1	KNOB	PPA	1	BLACK
NO.	PART NAME	MATERIAL	QTY.	FINISHING

DONGGUAN CITY JINBEILI ELECTRICAL TECHNOLOGY CO., LTD.

GENERAL TOLERANCE未指的公差		TITLE	
X. ± 0.15	X. ° ± 5°	名称	
.X ± 0.10	.X ° ± 2°	PART NO. 零件编号	
.XX ± 0.05	.XX ° ± 1°	DWG NO. 图纸编号	
.XXX ± 0.02	.XXX ° ± 0.5°	TC00100AH9.5F160	
APPROVAL 审批	CHECKED 核准	DRAWN 设计	
ROBIN	ROBIN	SCALE 比例	
		I:1	
		PROJ. REV.	
		TC00100	

<b>东莞市金倍利电器科技有限公司</b> DONGGUAN CITY JINBEILI ELECTRICAL TECHNOLOGY CO., LTD.		文件编号 FILE NO.	页码 PAGE	1/6
		发布日期 DATE OF ISSUE		
PRODUCT SPECIFICATION 产品承认书		文件版本 EDITION	第 A 版 第 0 次修订	
Title 名称	TACT SWITCH 轻触开关	产品料号 PART NO.	TC00100AH9.5F160	

### 1. General Characteristics 一般特性:

Applicating: This Specification is applied tk rotary tact switch used for general application.

适用范围: 该承认书适用于轻触开关的一般使用范围.

Operating Temperature Range:  $-40^{\circ}\text{C} \sim +85^{\circ}\text{C}$

使用温度范围:  $-40^{\circ}\text{C} \sim +85^{\circ}\text{C}$

1.3 Operating Relative Humidity:  $\leq 85\% \text{ RH}$

相对湿度:  $\leq 85\% \text{ RH}$

Test Conditions: Unless ktherwise specified, the atmospheric conditions for making measurements and tests are as follows:

实验条件: 若没有特别说明, 测试大气条件如下:

Environment Temperature:  $5 \sim 35^{\circ}\text{C}$

环境温度:  $5 \sim 35^{\circ}\text{C}$

Relative Humidity:  $45 \sim 85\%$

相对湿度:  $45 \sim 85\%$

Atmospheric Pressure:  $86 \sim 106\text{Kpa} (860 \sim 1060\text{mbar})$

大气压力:  $86 \sim 106\text{Kpa} (860 \sim 1060\text{mbar})$

### 2. Appearance, structure and Dimensions 外观, 结构尺寸:

2.1 Appearance The switch shall have good finishing, and no rust, crack or plating defects.

外观: 产品外观良好, 无锈蚀, 裂纹和镀层缺陷。

2.2 Structure & Dimensions Refer to individual product drawing.

结构及尺寸: 参见产品图纸

2.3 Markings Refer to individual product drawing.

标识: 参见产品图纸。

3. Ratings 额定负荷 DC 12V 0.05A

### 4. Electrical Characteristics 电气特性

NO.	Item 项目	Criteria 标准	Test Method 实验方法
4.1	Contact Resistance 接触电阻	$100\text{m}\Omega \text{ Max}$	Measured by a voltage drop method at $1\text{mA Max}, 5\text{VDC}$ . Any equipment with error not more than 5% can be used. Resistance after test in the average of 5 successive measurements (To measure after operated 5 to 10 times) 以 $1\text{mA}, 5\text{V}$ 直流电, 采用电压降法测量。也可用误差不超过 5% 的仪表进行测量, 实验后的电阻取 5 次测量的平均值。(按动 5-10 次后测量)
4.2	Insulation Resistance 绝缘电阻	$100\text{M}\Omega \text{ Min}$	100V DC voltage is applied between each pair of terminals between the terminal and the metal frame for $60 \pm 5\text{S}$ 在相互绝缘的所有端子之间及各接线端子与外露的非载流金属零件之间加载 100V 直流电, 持续时间 $60 \pm 5\text{S}$
4.3	Dielectric Voltage 抗电强度	No dielectric breakdown shall occur 无击穿现象发生。	250VAC is applied between non-connected terminals and between terminals and the metal frame for $60 \pm 5\text{S}$ 在相互绝缘的所有端子之间及各接线端子与外露的非载流金属零件之间加载 250V 交流电, 持续时间 $60 \pm 5\text{S}$

<b>东莞市金倍利电器科技有限公司</b> DONGGUAN CITY JINBEILI ELECTRICAL TECHNOLOGY CO., LTD		文件编号 FILE NO.		页码 PAGE	2/6
		发布日期 DATE OF ISSUE			
PRODUCT SPECIFICATION 产品承认书		文件版本 EDITION	第 A 版 第 0 次修订		
Title 名称	TACT SWITCH 轻触开关	产品料号 PART NO.	TC00100AH9.5F160		

### 5.Mechanical Characteristics 机械特性

NO.	Item 项目	Criteria 标准	Test Method 实验方法
5.1	Operating Force 操作力	160gf±50gf	Apply a tension load on the midpoint of the actuator(or tip of the shaft)tk supply a pressure vertically from its free position to operating position. 在操作元件末端沿操作方向均匀施加静载荷, 使操作元件从自由位置转换动作位置.
5.2	Return Force 回弹力	50gf Min	The value to whichthe force in the actuator midpoint(or tip of the shaft)must bk reduced to allow the contact to the normal position. 在操作元件末端沿操作方向均匀减少静载荷, 使操作元件从动作位置转换自由位置.
5.3	Travel 行程	0.25±0.1mm	Place the switch such that the direction of switch Operation is vertical and then apply a staic load twice the actuating force to the center of the stem, the travel distance for the stem to come to a stop shall be measured. 开关的动作方向为垂直放置开关, 并以双倍动作力的静负荷作用推柄中心, 测量推柄从开始到停止的行程距离
5.5	Terminal Strength 端子强度	Shall be free from terminal looseness, damage and insulator breakage No functional defectivr occur. 端子无松动, 损坏及绝缘层的破裂。无功能性不良.	A static load of 3N shall be applied to the tip of terminals for 10s in any direcion 任意方向施加 3N 作用于接线端末端, 持续时间 10s
5.6	Vibration Proof 振动	After test, Contact resistance: 200 mΩ max. Insulation resistance:50MΩ Min. The electrical performance Specified in item 4.3-4.5 shall be satisfied.No abnormalities shall be recognized in appearance and construction 实验后: 接触电阻: 200Ω max. 绝缘电阻: 50MΩ Min. 电气性能应符合第 4.3-4.5 条的要求。表面及结构无明显变形。	Switch shall be secured to a testing machine by a normal mounting device and method.Switch shall be tested according to the following request: (1) Vibration frequency range=10~55Hz (2) Total amplitude =1.5mm (3) Sweep ratio:10~55~10HZ Approx. 1min (4) Method of changing the sweep vibration frequency:linear (5) Direction of vibration:Three perpendicular directions including actuating direction. 开关采用常规的安装方式牢固地安装在试验设备上, 并在下述参数条件下进行试验: (1) 振频=10~55Hz (2) 振幅 1.5mm (3) 振动变化速率: 10-55-10HZ 大约 1 分钟 (4) 变频方法: 线性型式 (5) 振动方向: 三个相互垂直的方向, 其中一个方向是促动无件运动的方向。 (6) 时间: 每个方向 2 小时 (共 6 小时)

<b>东莞市金倍利电器科技有限公司</b> DONGGUAN CITY JINBEILI ELECTRICAL TECHNOLOGY CO., LTD		文件编号 FILE NO.		页码 PAGE	3/6
		发布日期 DATE OF ISSUE			
PRODUCT SPECIFICATION 产品承认书		文件版本 EDITION	第 A 版 第 0 次修订		
Title 名称	TACT SWITCH 轻触开关	产品料号 PART NO.	TC00100AH9.5F160		

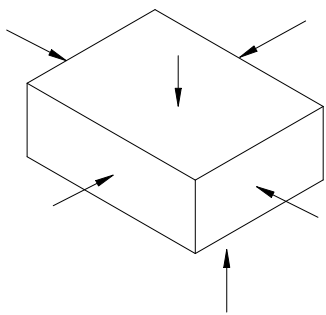
5.7	Mechanical Shock 冲击	<p>After test Contact resistance: 200 mΩ max. Insulation resistance: 50M Ω Min. The Electrical performance No functional defectivr occur. Shall be bree from mechanical abnormalities. 实验后: 接触电阻: 200 Ω max. 绝缘电阻: 50MΩ Min. 无功能性不良. 表面无变形且操作无异常。</p>	<p>Switch shall be tested according to the following request:</p> <p>(1) Mounting Method:Normal (2) Acceleration: 490m/S<sup>2</sup> (50G) (3) Duration: 11ms (4) Test Direction:6 directions</p>  <p>(5) Number of shoks:3times per direction (18times in total) 开关在下述参数条件下进行试验: (1) 安装方法: 常规方法 (2) 加速度: 490m/S<sup>2</sup> (50G) (3) 时间: 11ms (4) 实验方向: 图示 6 方向 (5) 每个方向 3 次 (总共 18 次)</p>
5.8	Solder Ability 可焊性	<p>More than 80% of immersed part shall be covered with solder. 超过 80%的浸锡面积被焊料所覆盖.</p>	<p>Switch shall be tesed according to the following request:</p> <p>(1)Equipment:Auto-Dip Chamber (2)Solder:Normal (3)Flux:Rosin Flux having a nominal composition of 25% solids by mass of white rosin in methyl alcohol solution. (4)Soldering Temperature:240±5℃ (5)Immersing Time:3±0.5s (6) Immersion depth: immersion depth shall be at copper plating portion of PCB after mounting. (Thickness of PCB=1.6mm) 开关在下述参数条件下进行试验: (1)设备:自动焊接机 (2)焊料:常规 (3)焊剂:焊剂质量百分比为 25%松,75% 的无色透明溶液 (4)焊接温度: 240±5℃ (5)浸渍时间: 3±0.5s (6) 浸渍深度:接线端应浸到离开根部 1.6mm 处.</p>

<b>东莞市金倍利电器科技有限公司</b> DONGGUAN CITY JINBEILI ELECTRICAL TECHNOLOGY CO., LTD		文件编号 FILE NO.		页码 PAGE	4/6
		发布日期 DATE OF ISSUE			
PRODUCT SPECIFICATION 产品承认书		文件版本 EDITION	第 A 版 第 0 次修订		
Title 名称	TACT SWITCH 轻触开关	产品料号 PART NO.	TC00100AH9.5F160		

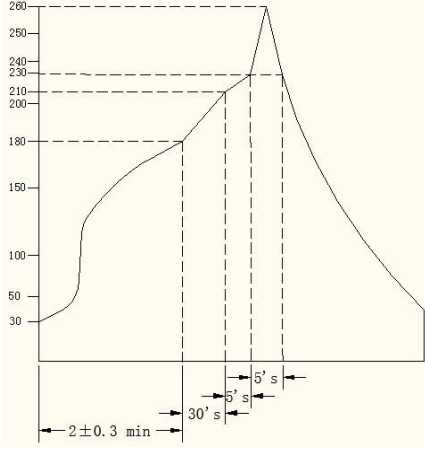
5.9	<b>Solder Heat Resistance</b> 耐焊接热	<p>NO abnormalities shall be observed in appearance and operation          无外观及功能损坏</p> 	<p>Switch shall be tested according to the following request:</p> <ol style="list-style-type: none"> <li>(1)Solder:Normal</li> <li>(2)Flux:Rosin Flux having a nominal composition of 25% solids by mass of white rosin in methyl alcohol solution.</li> <li>(3)Soldering Temperature &amp; Immersing Time          Dip soldering: 260±5°C 5±1s          Manual soldering: 350±5°C 2-3s</li> <li>(4)Immersion depth: (For Dip Soldering) immersion depth shall be at copper plating portion of PCB after mounting.          (Thickness of PCB=1.6mm)</li> </ol> <p>开关在下述参数条件下进行试验:</p> <ol style="list-style-type: none"> <li>(1)焊料:常规</li> <li>(2)焊剂:焊剂质量百分比为 25%松,75% 的无色透明溶液</li> <li>(3)焊接温度及浸渍时间:          自动焊接: 260±5°C 5±1s          手工焊接:350±5°C 2-3s</li> <li>(4)浸渍深度:(对于手动焊接)          接线端应浸到离开开关根部 1.6mm 处.</li> </ol>
5.10	<b>Resistance to Flux</b> 抗焊剂能力	<p>Flux shall not be risen up tk contact.          The switch shall be free from abnormalities in operation.          焊剂不得上升进入开关内部,影响接触转换.          试件在操作过程中不应发生变形.</p>	<p>Switch shall be tested according to the following request:</p> <ol style="list-style-type: none"> <li>(1)Solder:Normal</li> <li>(2)Flux:Rosin Flux having a nominal composition of 25% solids by mass of white rosin in methyl alcohol solution.</li> <li>(3)Soldering Temperature:245±5°C          Immersing Time:3±0.5s          Flux immersing time shall be at 5-10s in normal room temperature.</li> <li>(4) Immersion depth:          immersion depth shall be at copper plating portion of PCB after mounting.          (Thickness of PCB=1.6mm)</li> </ol> <p>开关在下述参数条件下进行试验:</p> <ol style="list-style-type: none"> <li>(1)焊料:常规</li> <li>(2)焊剂:焊剂质量百分比为 25%松,75% 的无色透明溶液</li> <li>(3)焊接温度: 260±5°C          浸渍时间: 3±0.5s          焊剂浸渍时间:5-10s</li> <li>(4)浸渍深度:接线端应浸到离开开关根部 1.6mm 处.</li> </ol>

<b>东莞市金倍利电器科技有限公司</b> DONGGUAN CITY JINBEILI ELECTRICAL TECHNOLOGY CO., LTD		文件编号 FILE NO.	页码 PAGE	5/6
		发布日期 DATE OF ISSUE		
PRODUCT SPECIFICATION 产品承认书		文件版本 EDITION	第 A 版 第 0 次修订	
Title 名称	TACT SWITCH 轻触开关	产品料号 PART NO.	TC00100AH9.5F160	

6. Durability characteristics			
NO	Ltem 项目	Criteria 标准	Test Method 实验方法
6.1	Mechanical life 机械寿命	After test, Contact resistance: 2 Ω max. Insulation resistance: 50M Ω Min. Tolerance of operating force Disintegration shall be within 30% of specified value No functional defrctive occur The switch shall be free from abnormalities in appearance Construction. 实验后: 接触电阻: 2 Ω max. 绝缘电阻: 50M Ω Min. 操作力衰变应在 Σ ± 30% 以内 无功能性不良 开关外观及结构应无损坏	100,000 cycles of operation shall be performed continuously at a rate of 60 cycles per minute without load. 在不带负荷的条件下,速度为 60 次/分,在寿命试验设备上连续转换 100,000 次。

#### 7. Weather Proof Characteristics 耐候性能:

7.1	Cold Proof 低温	After test, Contact resistance: 200 m Ω max. Insulation resistance: 50M Ω Min. No functional defrctive occur The switch shall be free from abnormalities in appearance Construction. 实验后: 接触电阻: 200 Ω max. 绝缘电阻: 50M Ω Min. 无功能性不良 开关外观及结构应无损坏	After testing at -40 ± 2 °C for 96 hours, the switch shall be allowed to stand under normal temperature and humidity conditions for 1 hour, and measurement shall be made within 1 hour after that. Water drops shall be eliminated. 试件在 -40 ± 2 °C 的温控箱内保持 96 小时,然后在正常温度和湿度下恢复 1 小时,并在此后 1 小时内对试品进行测量,水滴应消失。
7.2	Hot Proof 高温	After test, Contact resistance: 200 m Ω max. Insulation resistance: 50M Ω Min. No functional defrctive occur The switch shall be free from abnormalities in appearance Construction. 实验后: 接触电阻: 200 Ω max. 绝缘电阻: 50M Ω Min. 无功能性不良 开关外观及结构应无损坏	After testing at 70 ± 2 °C for 96 hours, the switch shall be allowed to stand under normal temperature and humidity conditions for 1 hour, and measurement shall be made within 1 hour after that. 试件在 70 ± 2 °C 的温控箱内保持 96 小时,然后在正常温度和湿度下恢复 1 小时,并在此后 1 小时内对试品进行测量,水滴应消失。
7.3	Moisture Resistance 恒定湿热	After test, Contact resistance: 200 m Ω max. Insulation resistance: 50M Ω Min. No functional defrctive occur The switch shall be free from abnormalities in appearance Construction. 实验后: 接触电阻: 200 Ω max. 绝缘电阻: 50M Ω Min. 无功能性不良 开关外观及结构应无损坏	After testing at 40 ± 2 °C, 90 ~ 95% RH for 96 hours, the switch shall be allowed to stand under normal temperature and humidity conditions for 1 hour, and measurement shall be made within 1 hour after that. Water drops shall be eliminated. 试件在 40 ± 2 °C, 90 ~ 95% RH 的温控箱内保持 96 小时,然后在正常温度和湿度下恢复 1 小时,并在此后 1 小时内对试品进行测量,水滴应消失。

<b>东莞市金倍利电器科技有限公司</b> DONGGUAN CITY JINBEILI ELECTRICAL TECHNOLOGY CO., LTD		文件编号 FILE NO.		页码 PAGE	6/6
		发布日期 DATE OF ISSUE			
PRODUCT SPECIFICATION 产品承认书		文件版本 EDITION	第 A 版 第 0 次修订		
Title 名称	TACT SWITCH 轻触开关	产品料号 PART NO.	TC00100AH9.5F160		

7.4	<b>Temperature Cycling</b> 温度转换	After test, Contact resistance: $2\ \Omega$ max. Insulation resistance: $50M\ \Omega$ Min. No functional defrctive occur The switch shall be free from abnormalities in appearance Construction. 实验后: 接触电阻: $200\ \Omega$ max. 绝缘电阻: $50M\ \Omega$ Min. 无功能性不良 开关外观及结构应无损坏	After 5 cycles of following conditions the switch shall be allowed to stand under normal temperature and humidity conditions for 1hour,and measurement shall be made within 1hour after that.Water drops shall be eliminated. 试件按下述实验条件试验 5 次,然后在正常温度和湿度下恢复 1 小时,并在此后 1 小时内对试品进行测量,水滴应消失	
7.5	<b>Salt Mist</b> 盐雾实验	No remarkable corrosion shall be recognized in metal part 在金属件上没有腐蚀斑点。	The switch shall be checked after the following test: (1) Temperature: $35\pm 2^{\circ}\text{C}$ (2) Salt Solution: $5\pm 1\%$ (Solids by mass),immersing time:5minute. (3) After immersing,salt deposit shall be removed by unning water. (4) Duration: $4\pm 1$ hours 试件在下述实验后测量: (1) 温度 $35\pm 2^{\circ}\text{C}$ (2) 盐溶液浓度: $5\pm 1\%$ (质量百分比), 浸泡 5 分钟。 (3) 浸泡后的盐沉积物用水冲掉。 (4) 时间 48 小时	

编制:	审核:	核准:
日期:	日期:	日期: